

## LTA-LSA szellőztető nyomógomb/ szellőztető kapcsoló

HU Szerelési útmutató

147695-04



**Germany**  
GEZE Sonderkonstruktionen GmbH  
Planken 1  
97944 Boxberg-Schweigern  
Tel. +49 (0) 7930 9294 0  
Fax +49 (0) 7930 9294 10  
E-Mail: sk.de@geze.com  
GEZE GmbH  
Niederlassung Süd-West  
Tel. +49 (0) 7152 203 594  
E-Mail: leonberg.de@geze.com  
GEZE GmbH  
Niederlassung Süd-Ost  
Tel. +49 (0) 7152 203 6440  
E-Mail: muenchen.de@geze.com  
GEZE GmbH  
Niederlassung Ost  
Tel. +49 (0) 7152 203 6840  
E-Mail: berlin.de@geze.com  
GEZE GmbH  
Niederlassung Mitte/Luxemburg  
Tel. +49 (0) 7152 203 6888  
E-Mail: frankfurt.de@geze.com  
GEZE GmbH  
Niederlassung West  
Tel. +49 (0) 7152 203 6770  
E-Mail: essen.de@geze.com  
GEZE GmbH  
Niederlassung Nord  
Tel. +49 (0) 7152 203 6600  
E-Mail: hamburg.de@geze.com  
GEZE Service GmbH  
Tel. +49 (0) 1802 923392  
E-Mail: service-info.de@geze.com

**Austria**  
GEZE Austria  
E-Mail: austria.at@geze.com  
www.geze.at

**Baltic States**  
GEZE GmbH Baltic States office  
E-Mail: office-latvia@geze.com  
www.geze.com

**Benelux**  
GEZE Benelux B.V.  
E-Mail: benelux.nl@geze.com  
www.geze.be  
www.geze.nl

**Bulgaria**  
GEZE Bulgaria - Trade  
E-Mail: office-bulgaria@geze.com  
www.geze.bg

**China**  
GEZE Industries (Tianjin) Co., Ltd.  
E-Mail: chinasales@geze.com.cn  
www.geze.com.cn  
GEZE Industries (Tianjin) Co., Ltd.  
Branch Office Shanghai  
E-Mail: chinasales@geze.com.cn  
www.geze.com.cn  
GEZE Industries (Tianjin) Co., Ltd.  
Branch Office Guangzhou  
E-Mail: chinasales@geze.com.cn  
www.geze.com.cn  
GEZE Industries (Tianjin) Co., Ltd.  
Branch Office Beijing  
E-Mail: chinasales@geze.com.cn  
www.geze.com.cn

**France**  
GEZE France S.A.R.L.  
E-Mail: france.fr@geze.com  
www.geze.fr

**Hungary**  
GEZE Hungary Kft.  
E-Mail: office-hungary@geze.com  
www.geze.hu

**Iberia**  
GEZE Iberia S.R.L.  
E-Mail: info@geze.es  
www.geze.es

**India**  
GEZE India Private Ltd.  
E-Mail: office-india@geze.com  
www.geze.in

**Italy**  
GEZE Italia S.r.l.  
E-Mail: italia.it@geze.com  
www.geze.it

GEZE Engineering Roma S.r.l.  
E-Mail: roma@geze.biz  
www.geze.it

**Poland**  
GEZE Polska Sp.z o.o.  
E-Mail: geze.pl@geze.com  
www.geze.pl

**Romania**  
GEZE Romania S.R.L.  
E-Mail: office-romania@geze.com  
www.geze.ro

**Russia**  
OOO GEZE RUS  
E-Mail: office-russia@geze.com  
www.geze.ru

**Scandinavia – Sweden**  
GEZE Scandinavia AB  
E-Mail: sverige.se@geze.com  
www.geze.se

**Scandinavia – Norway**  
GEZE Scandinavia AB avd. Norge  
E-Mail: norge.se@geze.com  
www.geze.no

**Scandinavia – Denmark**  
GEZE Danmark  
E-Mail: danmark.se@geze.com  
www.geze.dk

**Singapore**  
GEZE (Asia Pacific) Pte, Ltd.  
E-Mail: gezessea@geze.com.sg  
www.geze.com

**South Africa**  
GEZE Distributors (Pty) Ltd.  
E-Mail: info@gezesa.co.za  
www.geze.co.za

**Switzerland**  
GEZE Schweiz AG  
E-Mail: schweiz.ch@geze.com  
www.geze.ch

**Turkey**  
GEZE Kapi ve Pencere Sistemleri  
E-Mail: office-turkey@geze.com  
www.geze.com

**Ukraine**  
LLC GEZE Ukraine  
E-Mail: office-ukraine@geze.com  
www.geze.ua

**United Arab Emirates/GCC**  
GEZE Middle East  
E-Mail: gezeme@geze.com  
www.geze.ae

**United Kingdom**  
GEZE UK Ltd.  
E-Mail: info.uk@geze.com  
www.geze.com

### GEZE GmbH

Reinhold-Vöster-Straße 21–29  
71229 Leonberg  
Germany

Tel.: 0049 7152 203 0  
Fax: 0049 7152 203 310  
www.geze.com



## Megnevezés

Szellőztető nyomógomb/szellőztető kapcsoló, 1-es keret AS 500 alpinfehér, Any. sz. 118476.

## Tartozékok

| Név  | Any. sz. |
|--|----------|
| AS 500 sülllesztett keret                  |          |
| □ 1-es                                     | 115376   |
| □ 2-es                                     | 115377   |
| □ 3-as                                     | 115378   |
| □ 4-es                                     | 115379   |
| □ 5-ös                                     | 115380   |
| AS 500 falon kívüli doboz                  |          |
| □ 1-es                                     | 120503   |
| □ 2-es                                     | 128609   |
| □ 3-as                                     | 133206   |
| 55x55 közbenső keret ST 550-hez alpinfehér | 155851   |
| 55x55 közbenső keret LS 990-hez alpinfehér | 148997   |
| 55x55 közbenső keret LS 990-hez nemesacél  | 131822   |
| AS 500 BAB vakburkolat                     | 118480   |
| SCT (1-pól.)                               | 117996   |

## Hozzáillő kapcsolócsaládok

### Jung

- AS 500
- LS 990 (közbenső kerettel)
- ST550 (közbenső kerettel)

### Gira

- Standard 55
- E2
- Event

### Merten

- M rendszer

### Feller

- EDIZIOdue

### Berker

- B3
- B7
- S1

## Műszaki adatok

| Változat  | Feszültség | Áram      |
|-----------|------------|-----------|
| LTA-LSA   | 230 V AC   | max. 10 A |
| Védettség | IP 40      |           |

## Méretvázlatok

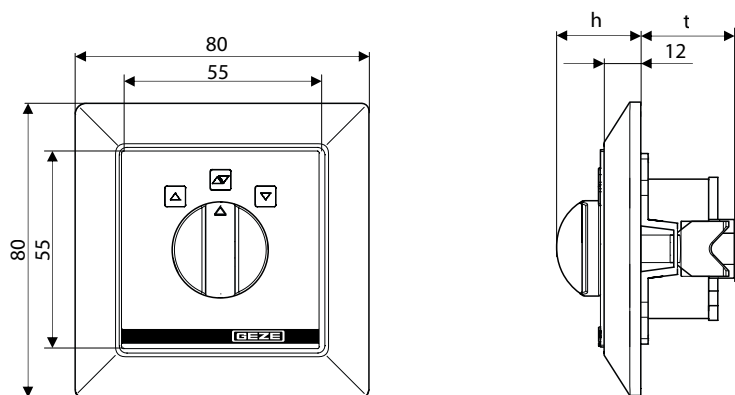

## Összeszerelés

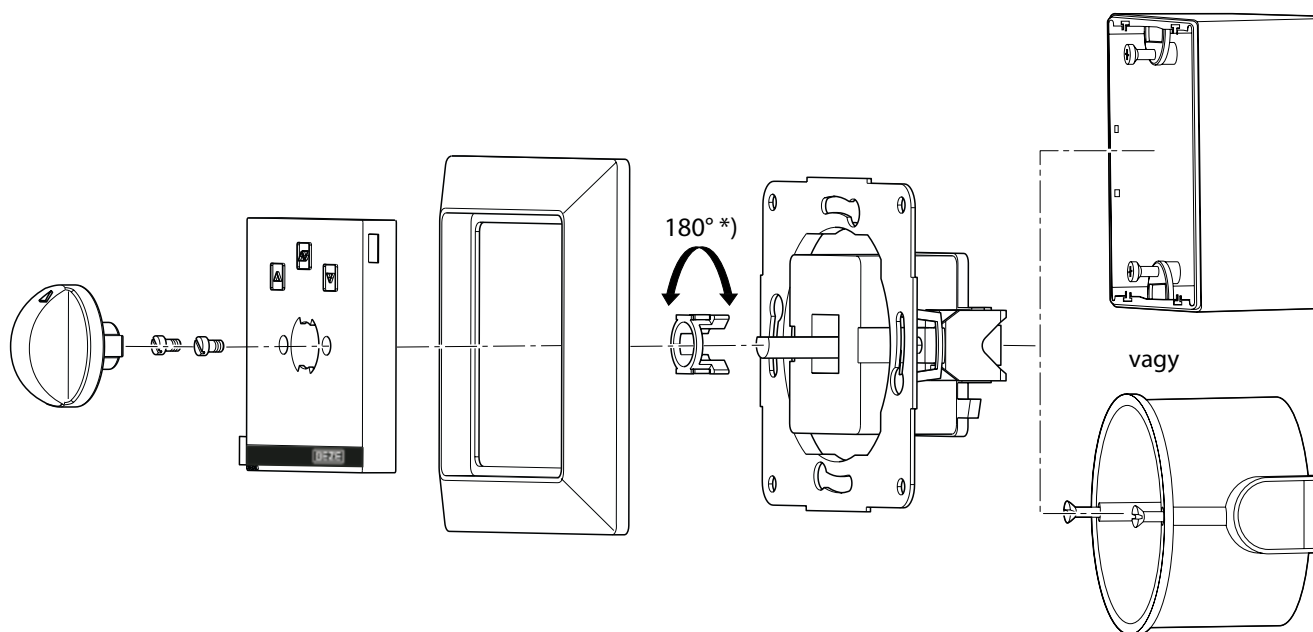

\*) választható kapcsoló- vagy reteszfunkció;  
kiszállítási állapot: reteszelve

# Sablon oszlopra (lizénára) történő szereléshez



A papírsablon mérete a levegő páratartalmának függvényében változhat. Ezért csak az alábbi méretadatok kötelezőek.

► A papírsablon használata előtt ellenőrizze és szükség esetén korrigálja annak méreteit.

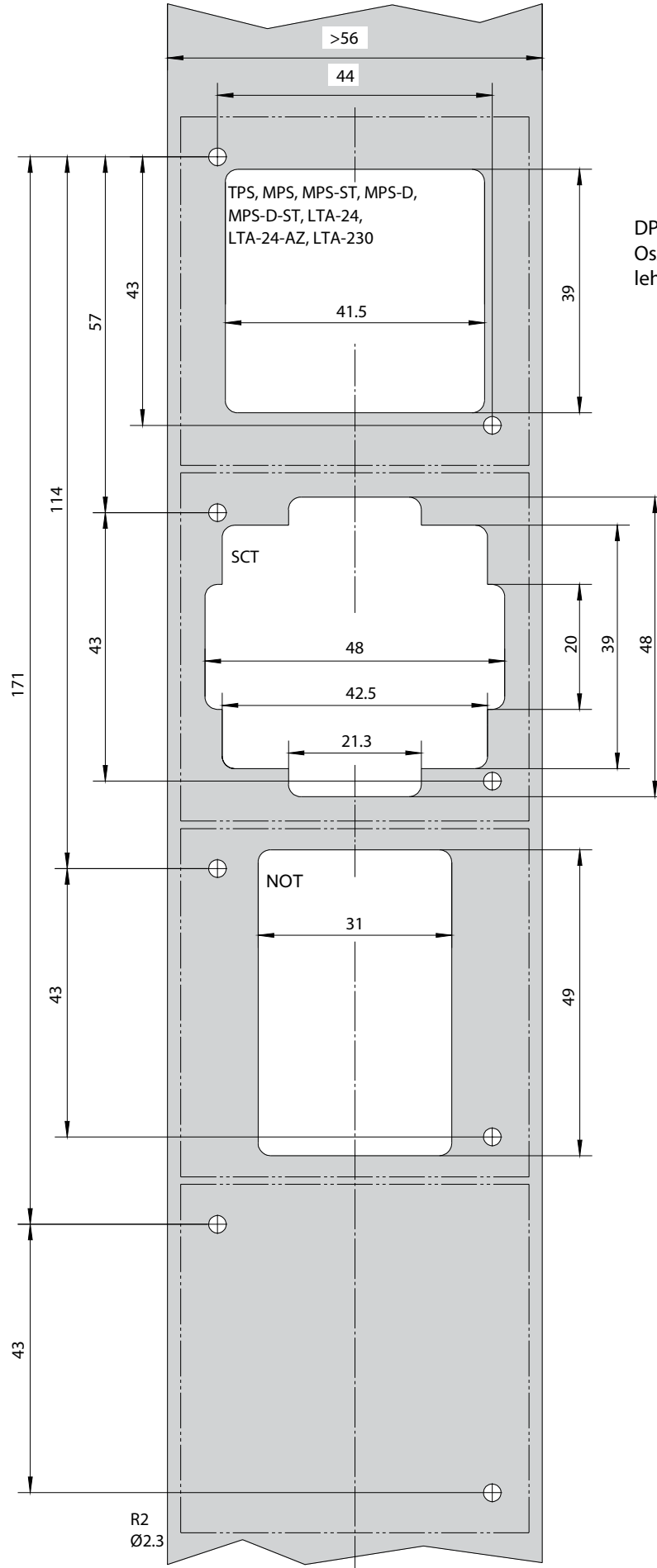

DPS, LTA-LSA:  
Oszlopba (lizénába) szerelés nem lehetséges.

# Kapcsolási rajzok

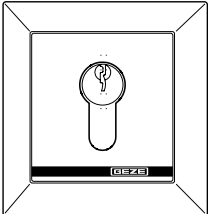
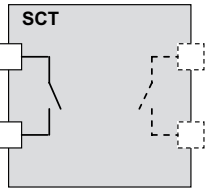
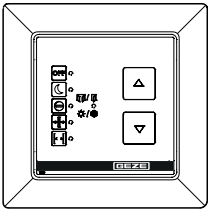
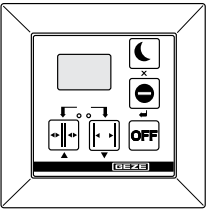
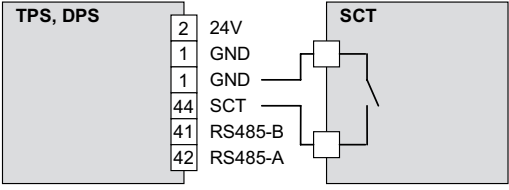
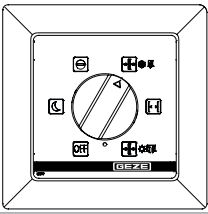
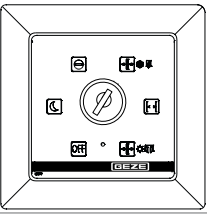
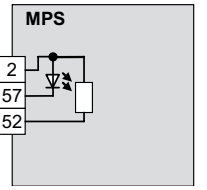
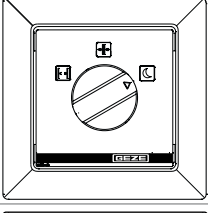
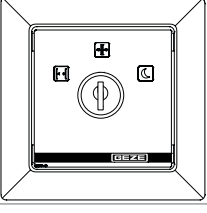
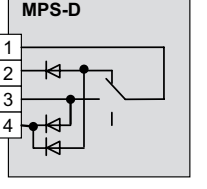
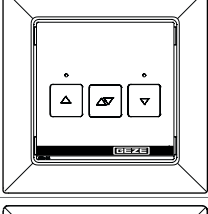
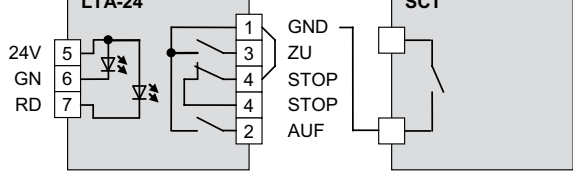
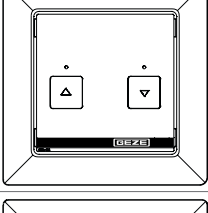
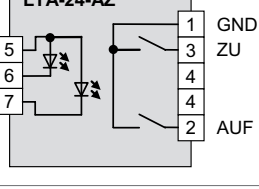
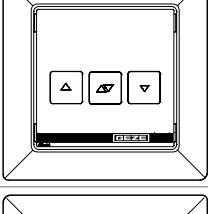
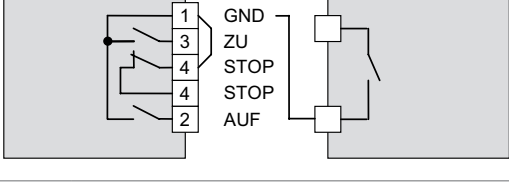
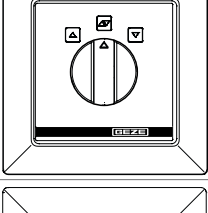
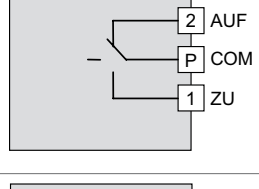
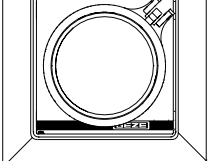
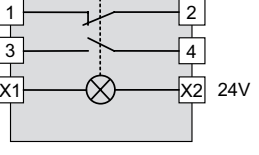
| Kapcsolók  | Megnevezés   | Any. sz.   | Kapcsolók  | Megnevezés | Any. sz. | Kapcsolási rajz   | h [mm] | t [mm]      |
|--|--|--|--|------------|----------|---|--------|-------------|
|    | SCT (1-pól.)   | 117996   |  | -          | -        |    | 11     | 31.9        |
|    | TPS<br>TPS-SCT<br>TPS-KDT<br>TPS-KDT-SCT<br>DPS<br>OFF gombbal<br>DPS<br>OFF gomb<br>nélkül<br>DPS<br>OFF SCT<br>gombbal | 113231<br>113232<br>126582<br>126583<br>151524<br>155809<br>155810 |   | TPS, DPS   |          |     | 11.3   | 5.3<br>31.9 |
|    | MPS  | 113226   |   | MPS-ST     | 113227   |    | 24     | 36          |
|   | MPS-D  | 118417   |  | MPS-D-ST   | 118418   |   | 24     | 36          |
|  | LTA-24<br>LTA-24-SCT   | 118473<br>127176   |  |            |          |   | 11     | 26          |
|  | LTA-24-AZ  | 129393   |  |            |          |  | 11     | 26          |
|  | LTA-230<br>LTA-230-SCT   | 118474<br>118475   |  |            |          |   | 11     | 26          |
|  | LTA-LSA  | 118476   |  |            |          |  | 24     | 32          |
|  | NOT  | 123132   |  |            |          |  | 54     | 56          |