

Mechanikus programkapcsoló MPS

HU Szerelési útmutató

159819-03



Germany
 GEZE Sonderkonstruktionen GmbH
 Planken 1
 97944 Boxberg-Schweigern
 Tel. +49 (0) 7930 9294 0
 Fax +49 (0) 7930 9294 10
 E-Mail: sk.de@geze.com
 GEZE GmbH
 Niederlassung Süd-West
 Tel. +49 (0) 7152 203 594
 E-Mail: leonberg.de@geze.com
 GEZE GmbH
 Niederlassung Süd-Ost
 Tel. +49 (0) 7152 203 6440
 E-Mail: muenchen.de@geze.com
 GEZE GmbH
 Niederlassung Ost
 Tel. +49 (0) 7152 203 6840
 E-Mail: berlin.de@geze.com
 GEZE GmbH
 Niederlassung Mitte/Luxemburg
 Tel. +49 (0) 7152 203 6888
 E-Mail: frankfurt.de@geze.com
 GEZE GmbH
 Niederlassung West
 Tel. +49 (0) 7152 203 6770
 E-Mail: essen.de@geze.com
 GEZE GmbH
 Niederlassung Nord
 Tel. +49 (0) 7152 203 6600
 E-Mail: hamburg.de@geze.com
 GEZE Service GmbH
 Tel. +49 (0) 1802 923392
 E-Mail: service-info.de@geze.com

Austria
 GEZE Austria
 E-Mail: austria.at@geze.com
 www.geze.at

Baltic States
 GEZE GmbH Baltic States office
 E-Mail: office-latvia@geze.com
 www.geze.com

Benelux
 GEZE Benelux B.V.
 E-Mail: benelux.nl@geze.com
 www.geze.be
 www.geze.nl

Bulgaria
 GEZE Bulgaria - Trade
 E-Mail: office-bulgaria@geze.com
 www.geze.bg

China
 GEZE Industries (Tianjin) Co., Ltd.
 E-Mail: chinasales@geze.com.cn
 www.geze.com.cn
 GEZE Industries (Tianjin) Co., Ltd.
 Branch Office Shanghai
 E-Mail: chinasales@geze.com.cn
 www.geze.com.cn
 GEZE Industries (Tianjin) Co., Ltd.
 Branch Office Guangzhou
 E-Mail: chinasales@geze.com.cn
 www.geze.com.cn
 GEZE Industries (Tianjin) Co., Ltd.
 Branch Office Beijing
 E-Mail: chinasales@geze.com.cn
 www.geze.com.cn

France
 GEZE France S.A.R.L.
 E-Mail: france.fr@geze.com
 www.geze.fr

Hungary
 GEZE Hungary Kft.
 E-Mail: office-hungary@geze.com
 www.geze.hu

Iberia
 GEZE Iberia S.R.L.
 E-Mail: info@geze.es
 www.geze.es

India
 GEZE India Private Ltd.
 E-Mail: office-india@geze.com
 www.geze.in

Italy
 GEZE Italia S.r.l.
 E-Mail: italia.it@geze.com
 www.geze.it

GEZE Engineering Roma S.r.l.
 E-Mail: roma@geze.biz
 www.geze.it

Poland
 GEZE Polska Sp.z o.o.
 E-Mail: geze.pl@geze.com
 www.geze.pl

Romania
 GEZE Romania S.R.L.
 E-Mail: office-romania@geze.com
 www.geze.ro

Russia
 OOO GEZE RUS
 E-Mail: office-russia@geze.com
 www.geze.ru

Scandinavia – Sweden
 GEZE Scandinavia AB
 E-Mail: sverige.se@geze.com
 www.geze.se

Scandinavia – Norway
 GEZE Scandinavia AB avd. Norge
 E-Mail: norge.se@geze.com
 www.geze.no

Scandinavia – Denmark
 GEZE Danmark
 E-Mail: danmark.se@geze.com
 www.geze.dk

Singapore
 GEZE (Asia Pacific) Pte, Ltd.
 E-Mail: gezesea@geze.com.sg
 www.geze.com

South Africa
 GEZE Distributors (Pty) Ltd.
 E-Mail: info@gezesa.co.za
 www.geze.co.za

Switzerland
 GEZE Schweiz AG
 E-Mail: schweiz.ch@geze.com
 www.geze.ch

Turkey
 GEZE Kapi ve Pencere Sistemleri
 E-Mail: office-turkey@geze.com
 www.geze.com

Ukraine
 LLC GEZE Ukraine
 E-Mail: office-ukraine@geze.com
 www.geze.ua

United Arab Emirates/GCC
 GEZE Middle East
 E-Mail: gezeme@geze.com
 www.geze.ae

United Kingdom
 GEZE UK Ltd.
 E-Mail: info.uk@geze.com
 www.geze.com

GEZE GmbH

Reinhold-Vöster-Straße 21–29
 71229 Leonberg
 Germany

Tel.: 0049 7152 203 0
 Fax: 0049 7152 203 310
 www.geze.com



Megnevezés

- Mechanikus programkapcsoló, forgatógomb, 1-es kerettel AS 500 alpinfehér, Any. sz. 113226
- Mechanikus programkapcsoló, kulcs, 1-es kerettel AS 500 alpinfehér, Any. sz. 113227

Tartozékok

Név	Any. sz.
AS 500 süllyesztett keret	
▫ 1-es	115376
▫ 2-es	115377
▫ 3-as	115378
▫ 4-es	115379
▫ 5-ös	115380
AS 500 falon kívüli doboz	
▫ 1-es	120503
▫ 2-es	128609
▫ 3-as	133206
55x55 közbenső keret ST 550-hez alpinfehér	155851
55x55 közbenső keret LS 990-hez alpinfehér	148997
55x55 közbenső keret LS 990-hez nemesacél	131822
AS 500 BAB vakburkolat	118480

Hozzáillő kapcsolócsaládok

Jung

- AS 500
- LS 990 (közbenső kerettel)
- ST550 (közbenső kerettel)

Merten

- M rendszer

Berker

- B3
- B7
- S1

Gira

- Standard 55
- E2
- Event

Feller

- EDIZIOdue

Műszaki adatok

- | | |
|---------------------------------------|---------------------------------------|
| □ Feszültség: | 24 V DC |
| □ Áramfelvétel: | 50 mA |
| □ Vezeték hossz, max.: | 100 m |
| □ Védettség: | IP 40 |
| □ Tárolás: | -20 °C ... 85 °C
nincs kondenzáció |
| □ Környezeti hőmérséklet üzem közben: | -15 °C ... 50 °C |
| □ EMC zavartűrés: | EN 61000-6-2 szerint |

Méretvázlatok

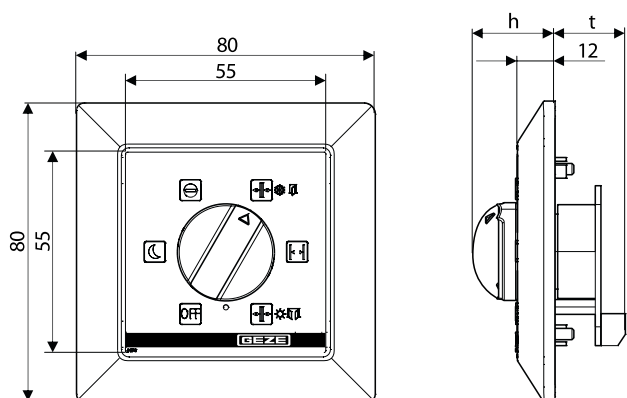

Összeszerelés

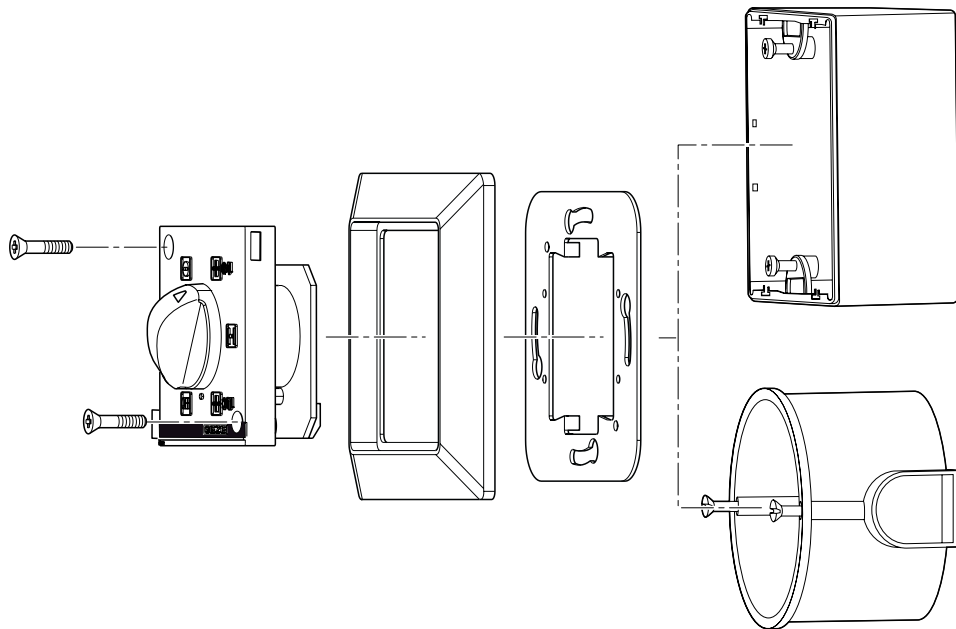

Sablon oszlopra (lizénára) történő szereléshez



A papírsablon mérete a levegő páratartalmának függvényében változhat. Ezért csak az alábbi méretadatok kötelezőek.

► A papírsablon használata előtt ellenőrizze és szükség esetén korrigálja annak méreteit.

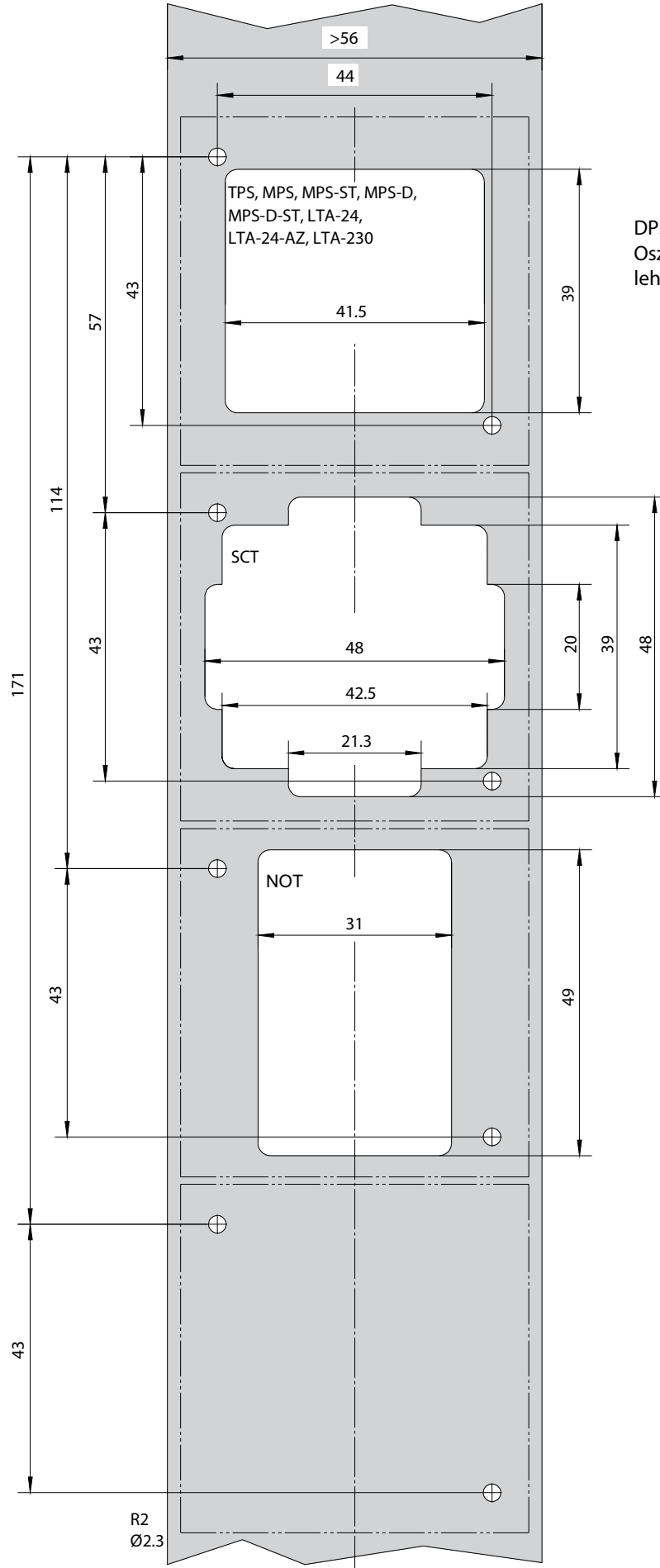

DPS, LTA-LSA:
Oszlopba (lizénába) szerelés nem lehetséges.

Kapcsolási rajzok

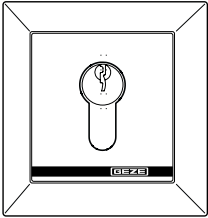
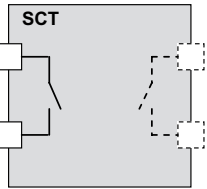
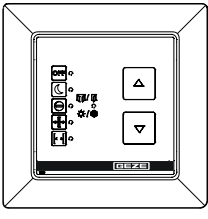
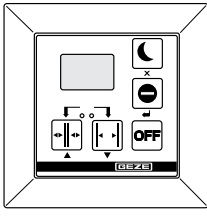
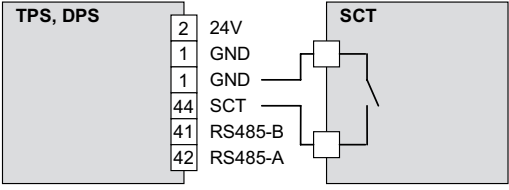
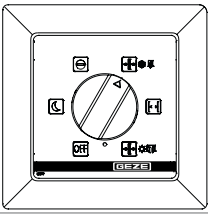
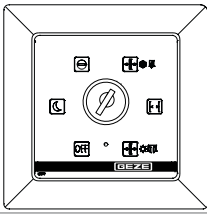
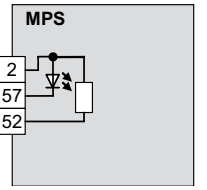
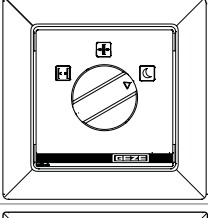
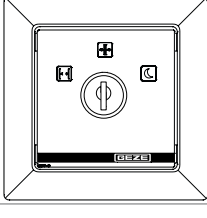
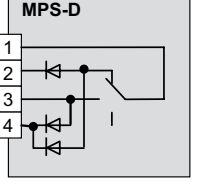
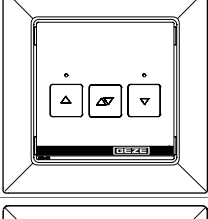
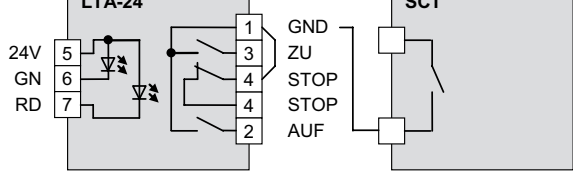
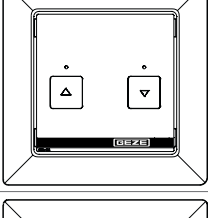
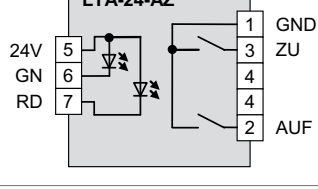
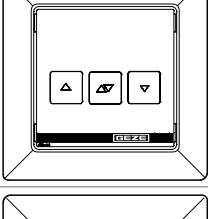
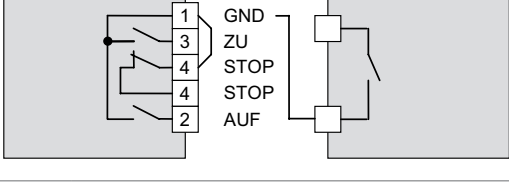
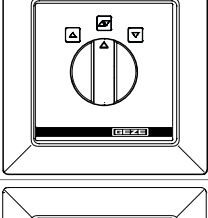
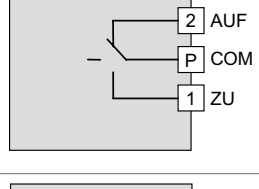
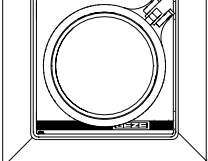
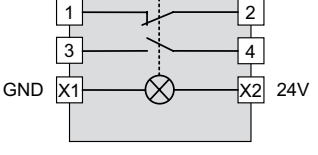
Kapcsolók	Megnevezés	Any. sz.	Kapcsolók	Megnevezés	Any. sz.	Kapcsolási rajz	h [mm]	t [mm]
	SCT (1-pól.)	117996		-	-		11	31.9
	TPS TPS-SCT TPS-KDT TPS-KDT-SCT DPS OFF gombbal DPS OFF gomb nélkül DPS OFF SCT gombbal	113231 113232 126582 126583 151524 155809 155810		TPS, DPS			11.3	5.3 31.9
	MPS	113226		MPS-ST	113227		24	36
	MPS-D	118417		MPS-D-ST	118418		24	36
	LTA-24 LTA-24-SCT	118473 127176					11	26
	LTA-24-AZ	129393					11	26
	LTA-230 LTA-230-SCT	118474 118475					11	26
	LTA-LSA	118476					24	32
	NOT	123132					54	56