



## GC 342+

### SAFETY SENSOR FOR AUTOMATIC SWING DOORS

User's Guide for software version SW 0100 and higher  
(refer to tracking label on product)

198709-00



## INSTALLATION TIPS



Avoid vibrations.

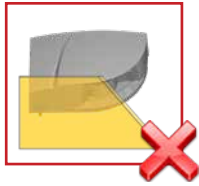

Do not cover the laser window.



Avoid moving objects and light sources in the detection field.



Avoid the presence of smoke and fog in the detection field.



Avoid condensation.

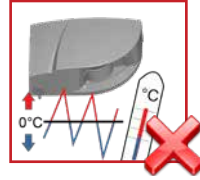

Avoid exposure to sudden and extreme temperature changes.

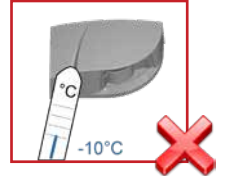

Keep the sensor permanently powered in environments where the temperature can descend below -10°C.

## MAINTENANCE TIPS

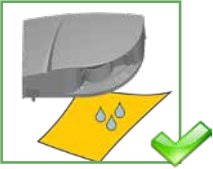

Clean the laser window with compressed air. If needed, wipe only with a soft, clean and damp microfibre cloth.



Do not use dry or dirty towels or aggressive products to clean the laser window.



Avoid direct exposure to high pressure cleaning.



The warranty is invalid if unauthorized repairs are made or attempted by unauthorized personnel.

## SAFETY TIPS

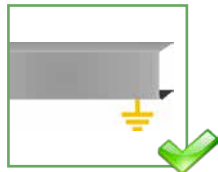

The door control unit and the door cover profile must be correctly earthed.



Only trained and qualified personnel may install and setup the sensor.



Always test the good functioning of the installation before leaving the premises.



- The device cannot be used for purposes other than its intended use. All other uses cannot be guaranteed by the manufacturer of the sensor.
- The manufacturer of the door system is responsible for carrying out a risk assessment and installing the sensor and the door system in compliance with applicable national and international regulations and standards on door safety.
- The manufacturer of the sensor cannot be held responsible for incorrect installations or inappropriate adjustments of the sensor.

## DESCRIPTION



The **GC 342+** is a safety sensor for automatic swing doors based on laser technology. It secures the moving door wing as well as the hinge area.

To do so, a module must be installed in the upper corner of the door wing on both sides of the door.

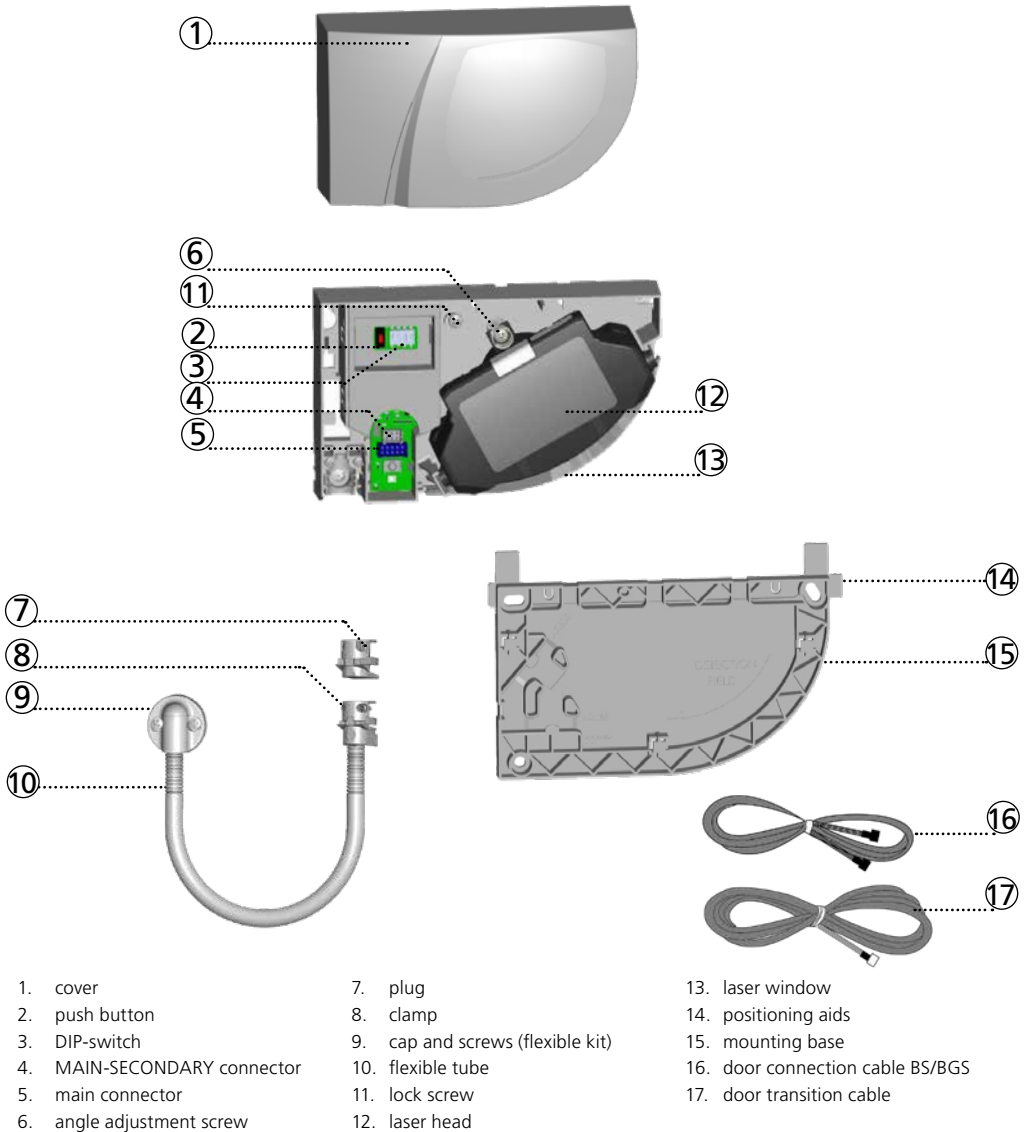

## LED-SIGNALS

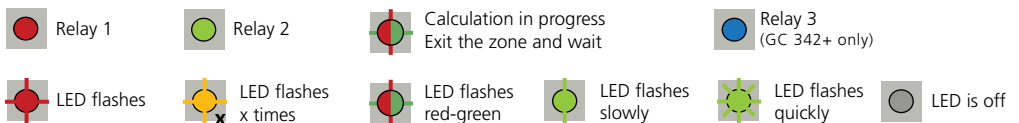

## 0 FOREWORD

The GC 342+ can be paired with another GC 342+ or a GC 342. The installation steps are identical for both product versions. For optimum safety and to access all features (e.g. opening functions), the GC 342+ must be connected to the door controller.

## 1 MOUNTING ON DOOR

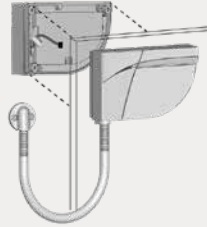
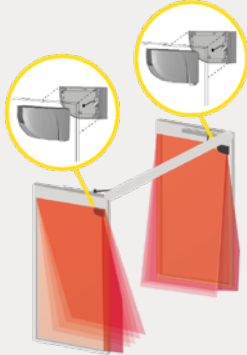

Keep a minimum distance of 15 cm between the GC342+ modules and radar sensors

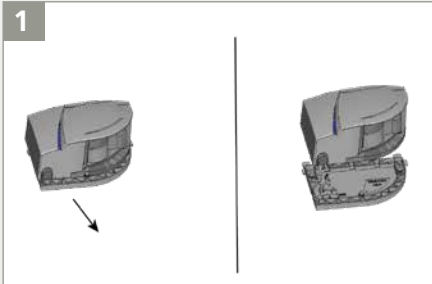

Slide the base off the sensor module.

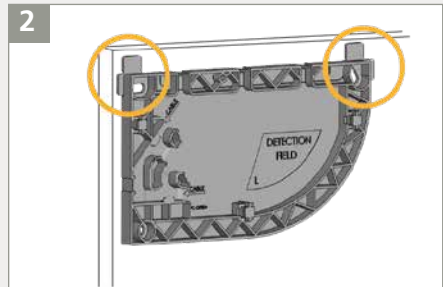

Take the base and put it on the door frame. The positioning aids help you to align the base correctly.



When mounting the base, make sure the sensor will not hinder the door movement. If the sensor isn't correctly positioned, it could be crushed during the opening of the door.

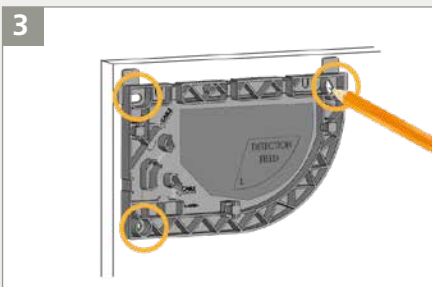

Using a pencil, mark the position of the holes to drill into the door frame. You can also use the inner surface of the base to fasten the screws.

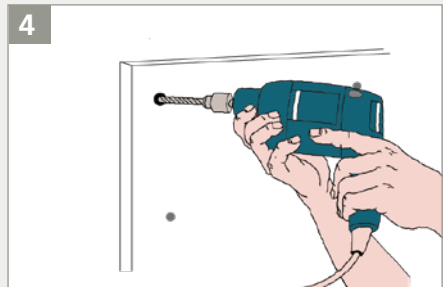

Remove the base and pre-drill the holes where marked.

5

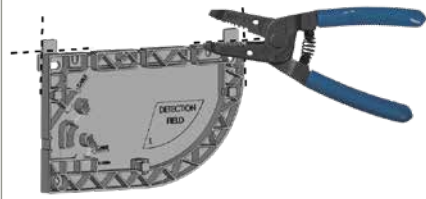

Using a wire cutter, remove the positioning aids from the base.

7

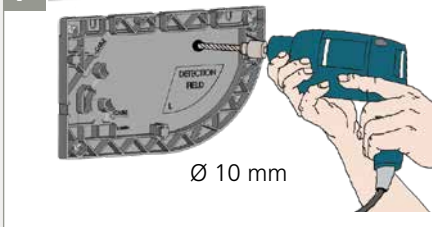

Drill through the 2 bases and the door using a 10 mm bit in order to pass the MAIN-SECONDARY cable. Soften the edges using a sheet of sandpaper.

9



Pass the cable through the hole on the back of the sensor and fasten the sensor on the base.

11

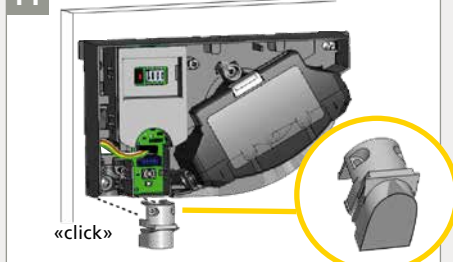

Close the sensor which will not be connected to the door controller using a plug.

⚙️ Sensor connected to other module = SECONDARY

6

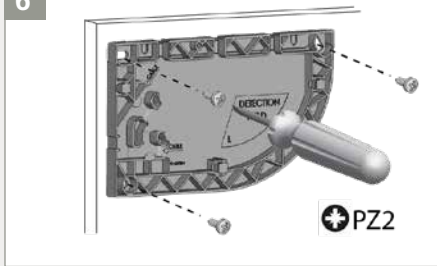

⚠️ Fasten the 3 screws using a Pozidrive screwdriver. The base needs to be fixed firmly!

8

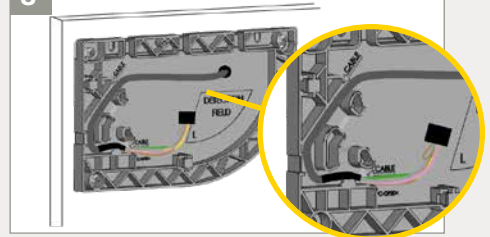

Take the MAIN-SECONDARY cable and pass it through the hole. Position the cable in the notch of the base and make sure it is firmly fixed.

10

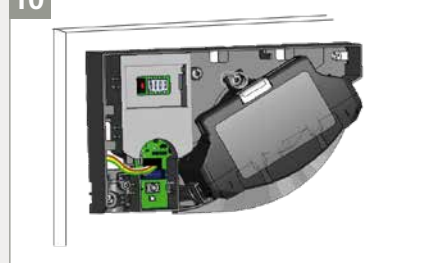

Connect the black plug to the black connector. Make sure that all wires are safely tucked within the notch to avoid crushing them with the cover.

12

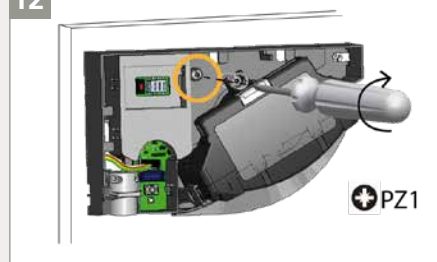

⚠️ Fasten the lock screw firmly.

## 2 WIRING TO DOOR CONTROLLER



We recommend connecting a GC 342+ to the door controller.



1 Take the flexible tube and determine how long it should be in order to reach the door controller.

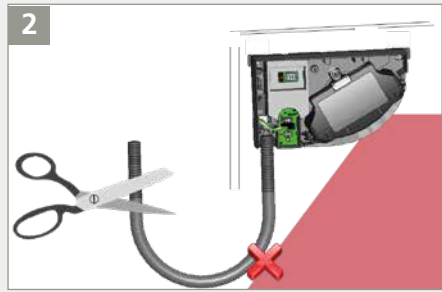

2 Cut the surplus to avoid undesired detections caused by the flexible tube.

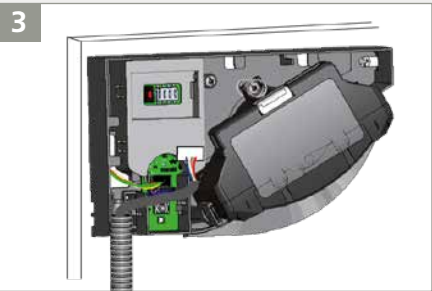

3 Pass the power cable through the flexible tube. Connect the white plug to the white connector.

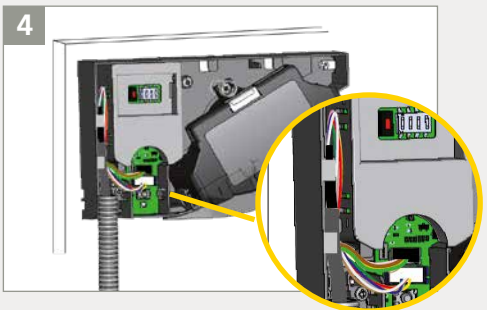

4 Make a loop with the wires of the power cable and pass them through the notch as indicated. Use the other part of the cable to block the wires.



Sensor connected to door controller = MAIN

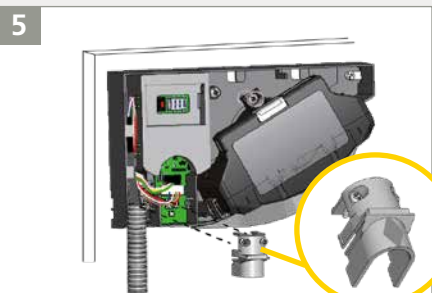

5 Take the clamp to fix the flexible tube to the sensor. Fasten the 2 screws firmly in order to avoid pulling out the cable.

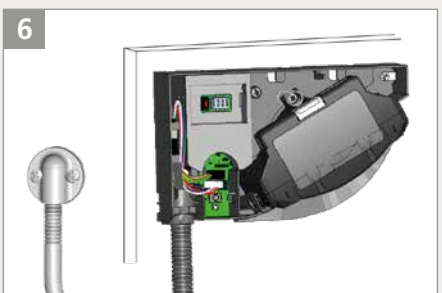

6 Tighten the other side of the flexible tube using the cable cap and pass through the rest of the power cable towards the door controller.

### 3 WIRING : CABLES

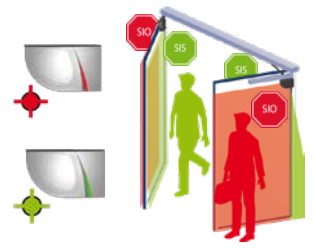
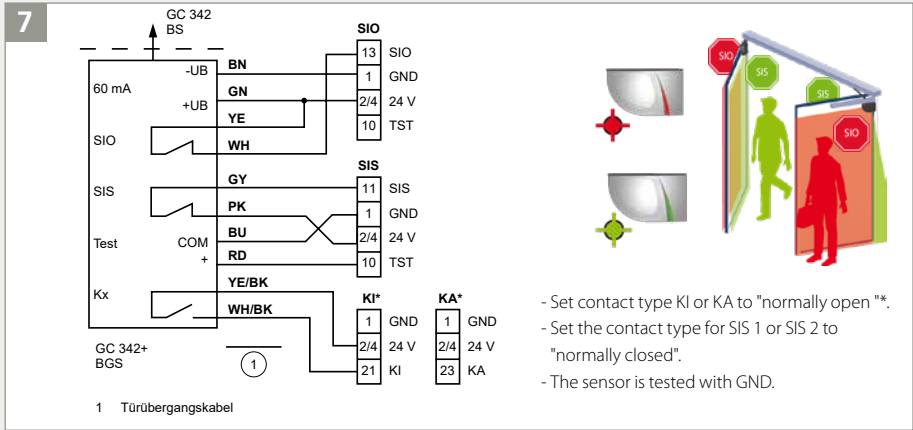

- Set contact type KI or KA to "normally open "\*\*.
- Set the contact type for SIS 1 or SIS 2 to "normally closed".
- The sensor is tested with GND.

**!** Cut the power cable to the right length, strip the 10 wires and connect all wires as indicated. The polarity of the power supply is important. For compliance with EN 16005 and DIN 18650, the door controller test output must be connected and able to test the sensor.

### 4 DIP SWITCH 1

Make sure the setting of DIP 1 is correct on all modules according to the door side.



RELAY 1: STOP-impuls on the opening side of the door



RELAY 2: REOPENING-impuls on the closing side of the door

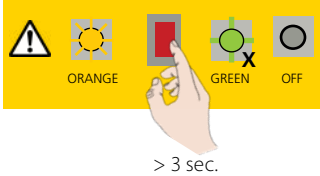
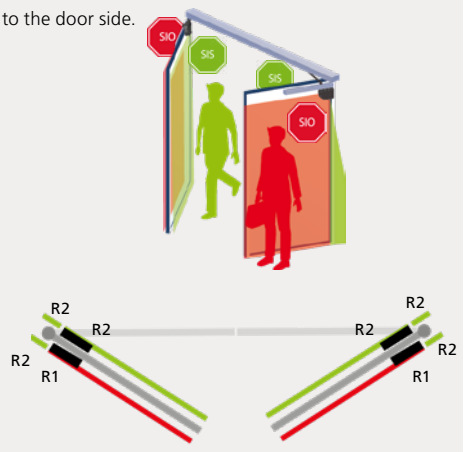

After changing a DIP-switch, the orange LED flashes. A LONG push on the push button confirms the settings. Afterwards, a number of green flashes (x) indicates the number of connected modules.

## 5 TEACH-IN



Before launching a teach-in, make sure that:

- **glass surfaces near the door are covered**
- the door controller is set up first
- the door is closed (use the service mode if needed, see above)
- the door controller is connected to all relay outputs and is fully reacting to them
- the MAIN-SECONDARY cable is connected between the modules
- the detection field is free of snow buildups, heavy rain, snowfall, fog or other objects or people

1. To launch a teach-in, press the push button of the MAIN\* module briefly. The LED starts to flash red-green quickly. When installing the sensor on a double swing door, repeat this on the other MAIN module.
2. Wait until all main sensors flash green. Position yourself in front of the door and stretch out your arm in front of you. Make an up and down movement at closing edge level in order to mark the limit of the detection zones. The LED flashes red while calculating the width of the door wings.
3. Wait until all main sensors flash green again. The GC 342+ will open the door to learn the environment (if the opening relay has been connected to the door controller). If the door doesn't open you can activate a door opening. **Make sure you are way outside of the detection field** (min. 2 m from the door). During the closing of the door, the sensor flashes red.
4. Once the door is completely closed again and the LED is off, the teach-in is completed.

\* A teach-in on the MAIN configures both the MAIN and the SECONDARY. A teach-in on the SECONDARY only configures the SECONDARY. In case the MAIN and SECONDARY modules are not aligned (same height or same distance from the hinge), first launch a teach-in on the MAIN and then on the SECONDARY.

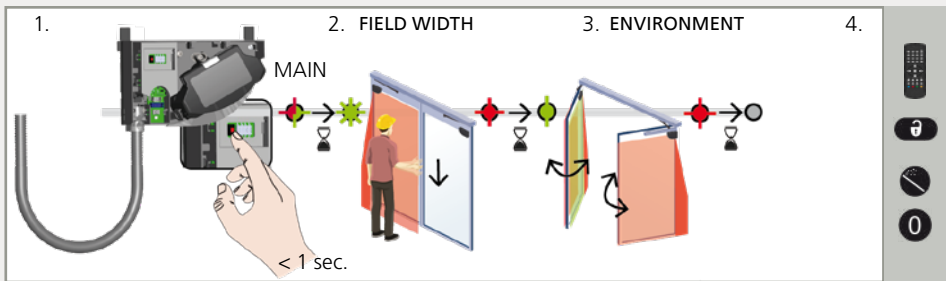

Launch a new teach-in each time the sensor tilt angle is changed or new objects are added to/changed in the detection zone.

## 6 TESTING AND ADJUSTING



Check the correct positioning of the safety fields by placing an object in the detection field.

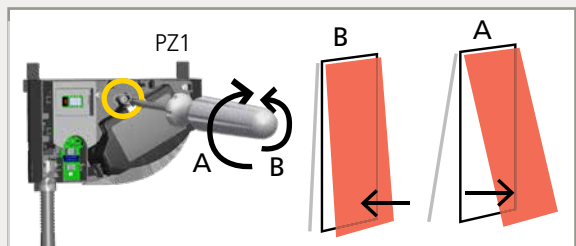

If necessary, adjust the tilt angle of the laser curtain by turning the tilt angle adjustment screw (from 0° to 5°)



After changing the angle, the sensor position or the environment, always launch a teach-in and test the correct positioning of the detection fields.



## 7 VIRTUAL OPENING BUTTONS

If needed, you can add virtual opening buttons (max. 2) in the second curtain. They can be used as activation zones to open the door manually, and can also be placed outside of the safety zones. To operate, the GC 342+ must be connected to the door controller with the cable provided (10 strands).

When the green LED flashes, hold your hand in the desired position to learn the virtual opening button. The LED flashes red to confirm the teach-in. Remove your hand: when the LED flashes green you can either learn another virtual opening button or wait 10 sec. until the end of the teach-in.

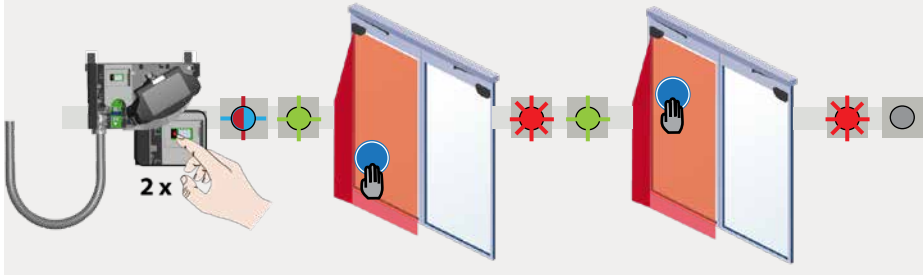

## 8 FINAL STEPS

### CLOSING

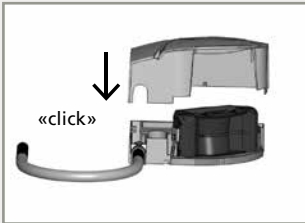

Close the cover starting on the narrow side. Do not hesitate to push.

### OPENING

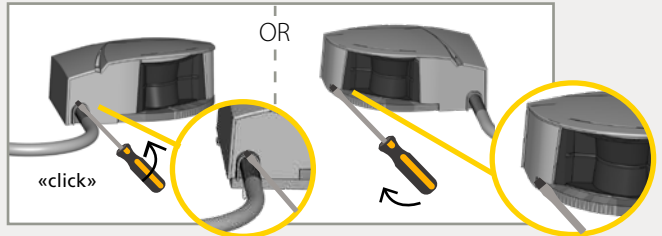

To open the sensor again, position a screwdriver in the notch and pull until the cover comes loose.

## EDGE ZONE (GC 342+ ONLY)

The GC 342+ provides an edge zone safeguarding the leading edge of the door leaf while the door is closing. The edge zone is activated when the door leaf is almost closed and aims to protect hands and fingers.

**Note :** the edge zone must be adjusted accordingly to the door type (cf. edge zone presets p. 10). For the edge zone to be fully operational, make sure relay 3 (OPEN) is connected to the door controller.

### Double leaf

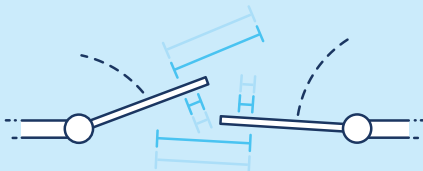

### Single leaf

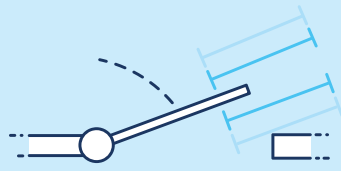

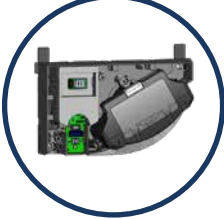







## DIP-SWITCH SETTINGS (OPTIONAL)



In order to adapt these parameters by remote control, set the corresponding DIP switch to ON.

	ON	OFF	
<b>DIP 2 ENVIRONMENT</b>	standard	critical	Switch to CRITICAL when external disturbances are likely to cause unwanted detections (min. obj size, immunity and uncovered zone are increased).
<b>DIP 3 BACKGROUND</b>	on	off	Switch to OFF when there is no background (glass floor, footbridge...). 
<b>DIP 4 HINGE ZONE</b>	on	off	Switch to OFF when the hinge area does not need to be secured or when objects added in the environment can cause unwanted detections.

After changing a DIP-switch, the orange LED flashes. A LONG push on the push button confirms the settings. Afterwards, a number of green flashes (x) indicates the number of connected modules.

## REMOTE CONTROL SETTINGS (OPTIONAL)

### DIMENSIONS OF ZONES

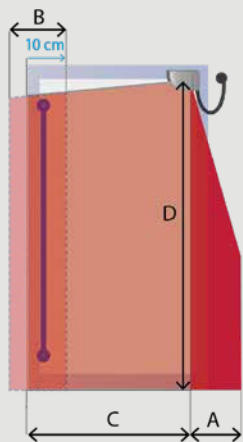

### Width of the hinge zone

 ↔ **000** **001** - **100** cm  
 no field      001      -      040      100\*

### Width of the edge zone

 ↔ **000** **001** - **100** cm  
 no field      001      -      005      100

### Width of the door zone

 ↔ **000** **001** - **400** cm  
 no field      001      -      400

### Height of all zones

 ↔ **000** **001** - **400** cm  
 no field      001      -      400

C and D : a teach-in overwrites these values automatically.

\* The actual dimensions depend on the mounting height (100 cm at 4 m). In order to change these settings by remote control, adjust **DIP-switch 4** to ON

### EDGE ZONE PRESETTINGS



**3**
**4**
**5**
**6**

No edge zone	Single leaf	Double leaf - first leaf to close	Double leaf - second leaf to close
--------------	-------------	-----------------------------------	------------------------------------

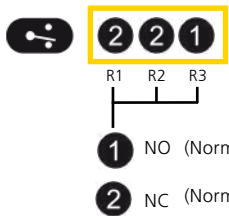
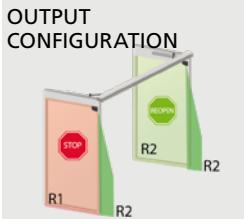
This presetting is mirrored to the other connected GC 342+ (from MAIN to SECONDARY and SECONDARY to MAIN).

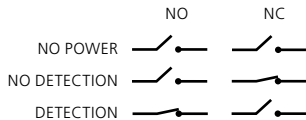

Always enter 3 digits for output parameters:  
 - 1st digit refers to the Output 1 (R1)  
 - 2nd digit refers to the Output 2 (R2)  
 - 3rd digit refers to the Output 3 (R3)



In order to change these settings by remote control, adjust DIP-switch 2 to ON

<b>F2</b>	1	2	3	4	5	6	7	
	2	4	6	8	10	12	14	cm*

Increase in case of snow, dead leaves, etc.

\* measured in specific conditions and dependant on application and installation.

### BACKGROUND / ANTIMASKING

In order to change these settings by remote control, adjust DIP-switch 3 to ON

«□»	0	1	2	3	
ANTIMASKING	OFF	OFF	ON	ON	
BACKGROUND	OFF	ON	OFF	ON	

Protective function which detects an unwanted object nearby the laser window masking the vision field.

### SAFETY FIELD DEPTH

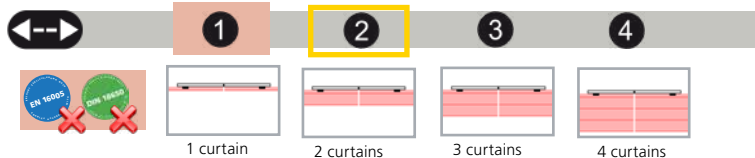

REOPEN side: During the opening cycle, the sensor always extends the safety depth up to 4 curtains to cover the whole door pathway.

### OPENING FIELD



### OPERATING MODE



**STATIC** - The detection field remains unchanged regardless of the door position. A wall masking is possible via the door controller.

**AUTO** - The GC 342+, when operating, is

- in dynamic mode when using two interconnected modules
- in static mode when using a single module

In dynamic mode, the GC 342+ dynamically adapts its detection fields according to the door position. An expanded field and wall masking are possible.

**MAN.** - This mode is used for manually operated automatic doors. The GC 342+ sets the reopening and opening signal on the hinge zone.

FACTORY VALUE

## HOW TO USE THE REMOTE CONTROL



After unlocking, the red LED flashes and the sensor can be adjusted by remote control.



If the red LED flashes quickly after unlocking, you need to enter an access code from 1 to 4 digits. If you do not know the access code, **cut and restore the power supply**. During 1 minute, you can access the sensor without introducing any access code.



To end an adjustment session, always lock the sensor.



It is recommended to use a different access code for each module in order to avoid changing settings on both modules at the same time.

### SAVING AN ACCESS CODE

The access code is recommended for sensors installed close to each other.



### DELETING AN ACCESS CODE



Enter the existing code

### ADJUSTING ONE OR MORE PARAMETERS

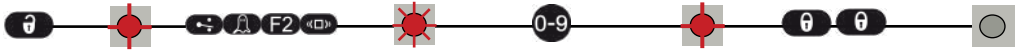

### CHECKING A VALUE



x = number of flashes = value of the parameter

2x 1x 3x 1x 5x = field width: 2.35 m

### RESTORING TO FACTORY VALUES



Factory reset of all values

Factory reset of all values except field dimensions and output configurations

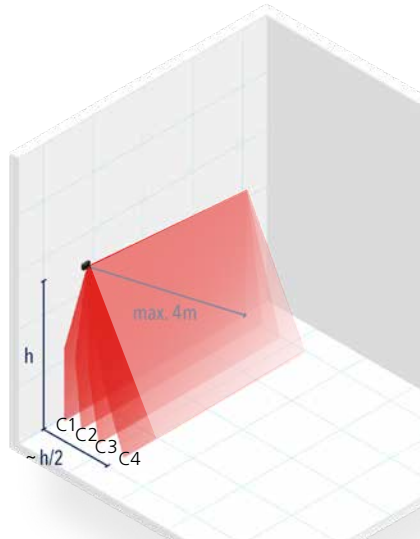
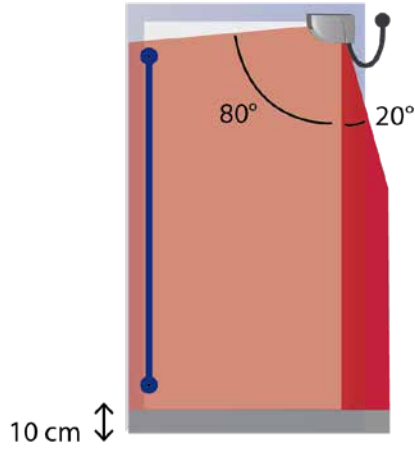

DOOR WING SAFETY

HINGE ZONE SAFETY

UNCOVERED ZONE  
Adjustable by remote control  
factory value: 10 cm

## SERVICE MODE

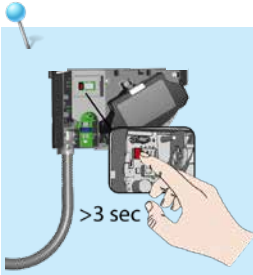

The service mode deactivates the door safety during 15 minutes and can be useful during an installation, a mechanical teach-in of the door or maintenance work.

To enter the service mode, push on the button for > 3 seconds.  
When the sensor is in service mode, the LED is off.  
To exit the service mode, push again for > 3 seconds.

The service mode is deactivated automatically when launching a teach-in.













## TROUBLESHOOTING



In case of unwanted reactions of the door, verify whether the problem is caused by the sensor, the door controller or a radar sensor in proximity. To do so, activate the service mode (no safety) and launch a door cycle. If the door cycle is completed successfully, check the sensor. If not, verify the door controller, the wiring or a radar sensor.

	The RED, GREEN or BLUE LED is ON sporadically or permanently and the door does not react as expected.	Bad teach-in	Launch a new teach-in (closed door).
		Unwanted detections (due to environment or external conditions)	1 Make sure the flexible cable does not cause detections.
			2 Verify if the laser window is dirty and clean it with compressed air. Then wipe it carefully with a damp and clean microfibre cloth if necessary (attention: the surface of the laser window is delicate)
			3 Launch a new teach-in (closed door).
4 Switch DIP 2 to off (critical environment).			
	The sensor does not react at power-on.	Inverted power supply	Check wiring (green +, brown -).
		Faulty cable	Replace cable
		Faulty sensor	Replace sensor
The sensor does not react when powered.	Test error	Check voltage between red and blue wires.	
		Press the push button during at least 3 seconds to exit the service mode.	
Opening function does not react at power on.	The opening function is deactivated during 30 seconds at power on.	Wait 30 seconds.	
	It is not possible to adjust a setting by remote control.	Wrong DIP-switch position.	Adjust the required DIP-switches to ON.
	The remote control does not react.	The sensor is protected by a password.	Enter the right password. If you forgot the code, cut and restore the power supply to access the sensor without entering a password during 1 minute.

	The ORANGE LED is on permanently.	The sensor encounters a memory problem.		Send the sensor back for a technical check-up.	
	The ORANGE LED flashes quickly.	DIP-switch setting awaiting confirmation.		Confirm the DIP-switch setting: long push on the push button.	
	The ORANGE LED flashes 1 x every 3 seconds.	The sensor signals an internal fault.		Cut and restore power supply. LED flashes again, replace sensor.	
	The ORANGE LED flashes 2 x every 3 seconds.	Power supply is out of limit.	1	Check power supply (voltage, capacity).	
			2	Reduce the cable length or change cable.	
		Internal temperature is too high.		Protect the sensor from any heat source (sun, hot air...)	
	The ORANGE LED flashes 3 x every 3 seconds.	Communication error between modules	1	Check wiring between MAIN and SECONDARY modules.	
			2	Check wiring between interface card and laser head.	
			3	Press the push button during 3 seconds if the MAIN-SECONDARY cable is permanently removed.	
	The ORANGE LED flashes 4 x every 3 seconds	The sensor does not see its background.		Turn off DIP 3 (deactivate background).	
			Something close to the sensor is masking part of the detection field.	1	Make sure the laser window is not scratched. If it is, replace sensor.
				2	Remove all masking elements (insects, spider web, flexible tube, window protection).
				3	Verify if the laser window is dirty and clean it with compressed air. Then wipe it carefully with a damp and clean microfibre cloth if necessary (attention: the surface of the laser window is delicate)
				4	Switch antimasking setting to off (attention: no conformity to DIN 18650 or EN 16005).
	The ORANGE LED flashes 5 x every 3 seconds.	Teach-in error	1	Check whether all teach-in requirements are fulfilled (see page 8) and launch a new teach-in (closed door).	
			2	Adjust the tilt angle of the laser curtain and launch a new tach-in (closed door).	
			3	Adjust the field dimensions by remote control. Push  and activate a door opening (step 3 of teach-in).	
		Permanent faulty measurements of door position.	1	Launch a new teach-in (closed door).	
			2	If orange LED flashes again, contact GEZE.	
	The ORANGE LED flashes 6 x every 3 seconds.	Sporadic faulty measurements of door position.	1	Clear field and wait until the door closes.	
			2	If the door does not close, cut power supply and restore it once the door is fully closed.	
			3	Launch a new teach-in (closed door).	

## TECHNICAL SPECIFICATIONS

<b>Technology</b>	LASER scanner, time-of-flight measurement
<b>Detection mode</b>	Presence
<b>Max. detection range</b>	4 m (diagonal) with reflectivity of 2% (i.e. : at W = 1.5m -> max. H = 3.7 m)
<b>Field of view</b>	Door wing safety: 80° / Hinge zone safety: 20°
<b>Resolution</b>	Curtain 1 : 500 spots (0.2° between spots) Curtain 2 : 100 spots (1° between spots) Curtain 3 : 60 spots (1.7° between spots) Curtain 4 : 40 spots (2.5° between spots)
<b>Typ. min. object size</b>	2cm @4m in curtain C1
<b>Testbody</b>	700 mm × 300 mm × 200 mm (testbody CA according to EN 16005 & DIN 18650)
<b>Emission characteristics (IEC 60825-1)</b>	IR LASER: wavelength 905 nm; output power < 0.1mW; Class 1
<b>Supply voltage</b>	12 - 24 V DC ± 15 % (to be operated from SELV compatible power supplies only)
<b>Power consumption</b>	< 2 W
<b>Response time</b>	Typ. <120 ms / Max. 220 ms (curtain 2)
<b>Output</b> Max. switching voltage Max. switching current	3 electronic relays (galvanic isolation - polarity free) 42V AC/DC 100 mA
<b>LED-signals</b>	1 RGB LED: detection/output status
<b>Dimensions</b>	145 mm (L) × 88 mm (H) × 60 mm (D) (mounting base + 7 mm)
<b>Material - Colour</b>	PC/ASA - Black - Aluminum - White
<b>Tilt angles</b>	0° to +5°
<b>Protection degree</b>	IP44 (EN 60529)
<b>Temperature range</b>	-25°C to +60°C
<b>Humidity</b>	0-95 % non-condensing
<b>Vibrations</b>	< 2 G
<b>Min. door wing speed</b>	2°/sec
<b>Conformity</b>	EN 12978; EN ISO 13849-1 Pl "d"/ CAT2; IEC 60825-1; EN 62061 SIL 2; DIN 18650-1 (testbody CA); EN 16005 (testbody CA)

Specifications are subject to change without prior notice.  
All values measured in specific conditions and with a specific temperature of 25°C

GEZE GmbH / Reinhold-Vöster-Straße 21-29 / 71229 Leonberg / Germany / Tel. +49(0) 7152-203-0 / Fax +49(0)7152-203-310 / www.geze.com



This product should be disposed of separately from unsorted municipal waste

